

Valve plug MJC 90° with cable LED+VDR V2A

PUR 2x0.75 bk 5m

Xtreme - Outdoor

Female 90°

12...24 V AC/DC

LED and VDR

Junior Timer

Stainless steel 1.4305 (V2A)

Plastic housings with good resistance against chemicals and oils.

The resistance to aggressive media should be individually tested for your application. Further details on request.

Further cable lengths on request.

[Link til produkt](#)

Illustrasjon

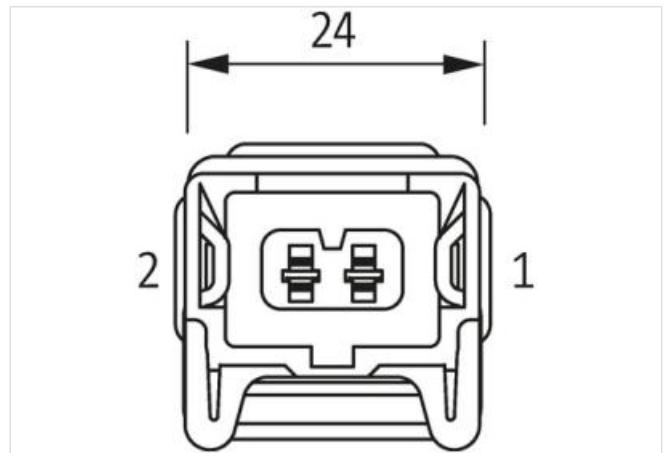
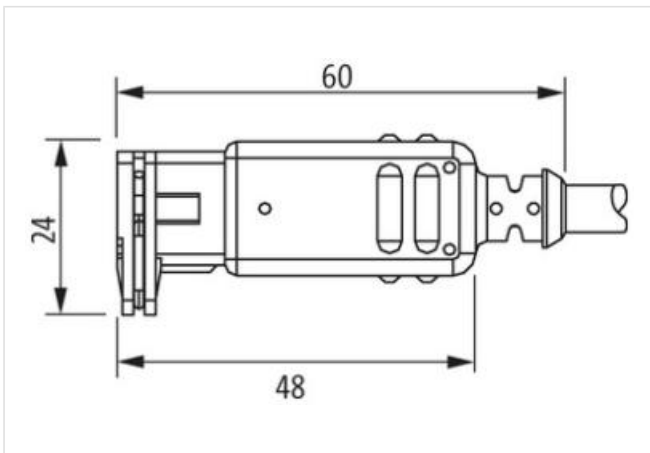
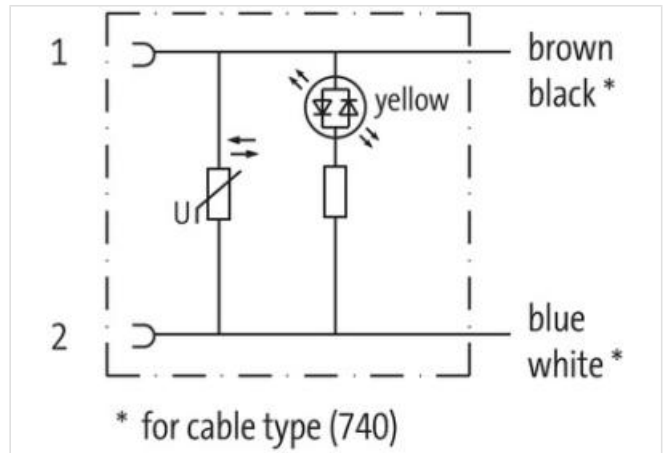

Produktet kan avvike fra bildet

Cable length 5 m

Handelsinformasjon

ECLASS-6.0	27279218
ECLASS-7.0	27279218
ECLASS-8.0	27279218

ECLASS-9.0	27060311
ECLASS-10.1	27060312
ECLASS-11.1	27060312
ECLASS-12.0	27060312
ETIM-5.0	EC001855
GTIN	4048879311410
Pakkestørrelse	1
Tolltariffnummer	85444290

Electrical data | Supply

Operating voltage AC min.	12 V
Operating voltage AC max.	24 V
Operating voltage DC min.	12 V
Operating voltage DC max.	24 V
Current operating per contact max.	4 A
Current consumption max.	12 mA

Diagnostics

Status indication LED	yellow
-----------------------	--------

Device protection | Electrical

Degree of protection (EN IEC 60529)	IP65
Additional condition protection degree	inserted, locked

Device protection | Media

Flame resistance	flame retardant
------------------	-----------------

Mechanical data | Material data

Color housing	black
Material housing	Plastic
Locking material	Stainless steel 1.4305 (V2A)

Environmental characteristics | Climatic

Operating temperature min.	-25 °C
Operating temperature max.	85 °C
Additional condition temperature range	depending on cable quality

Important installation notes

Note on strain relief	Protect the connectors by suitable measures from mechanical loads, e.g. by the usage of cable ties.
Note on bending radius	Attention: Observe the permissible bending radii when laying cables, as the IP protection class can be endangered by excessive bending forces.

Installation | Cable

wire arrangement	brown, blue
Cable identification	750
Jacket Color	black
Amount stranding	1
Stranding	2 wires twisted
Stranding factor min.	75 mm
Stranding factor max.	75 mm
wire arrangement	brown, blue
Cable weight	48,4 g/m
Material jacket	PUR
Shore hardness jacket	85 Shore A
Freedom from ingredients (jacket)	lead-free, CFC-free
Outer-diameter (jacket)	5,9 mm
Tolerance outer diameter (sheath)	± 5 %
Material inner jacket	PVC
Color (inner jacket)	gray

Material wire insulation	PVC
Amount wires	2
Outer diameter insulation	2 mm
Outer diameter tolerance core insulation	± 5 %
Shore hardness wire insulation	92 Shore A
Ingredient freeness wire insulation	lead-free, CFC-free
Amount strands (wire)	24
Diameter of single wires	0,2 mm
Conductor crosssection (wire)	0,75 mm ²
Material conductor wire	Stranded copper wire, bare
Conductor type (wire)	Strand class 5
Nominal voltage AC max.	300 V
Current load capacity (standard)	to DIN VDE 0298-4
Current load capacity min. wire	12 A
Electrical resistance line constant wire	26 Ω/km @ 20 °C
AC withstand voltage (wire - wire)	2 kV @ 60 s
Power frequency withstand voltage (wire - jacket)	2 kV @ 60 s
Min. operating temperature (static)	-40 °C
Max. operating temperature (fixed)	80 °C
Operating temperature min. (dynamic)	-5 °C
Operating temperature max. (dynamic)	80 °C
UV resistance	DIN EN ISO 4892-2 A
Flame resistance	UL 1581 § 1100 FT2 IEC 60332-2-2 UL 1581 § 1090
chemical resistance	Good, application-related testing
Gasoline resistance	Good, application-related testing
Oil resistance	Good, application-related testing DIN EN 60811-404
Bending radius (dynamic)	15 x Outer diameter