

**MSUD double valve A-18mm with cable**

PUR 4x0.75 gy UL/CSA 10m

Form A (18 mm)

110 V AC/DC ±10%

LED and suppression

Connection cable L = 150 mm

Further cable lengths on request.

Plastic housings with good resistance against chemicals and oils.

The resistance to aggressive media should be individually tested for your application. Further details on request.

[Link til produkt](#)

**Illustrasjon**

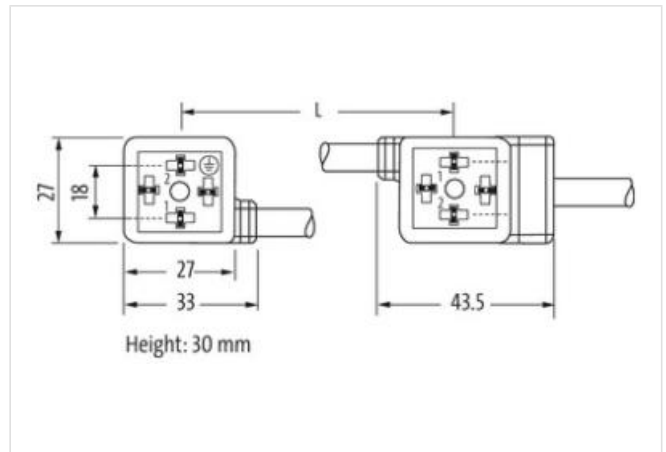
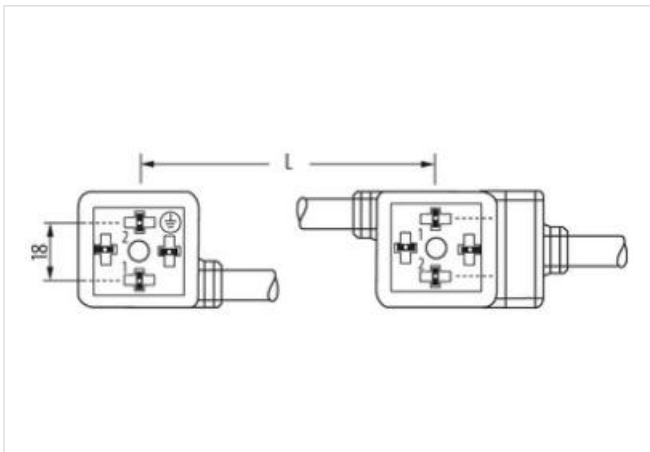
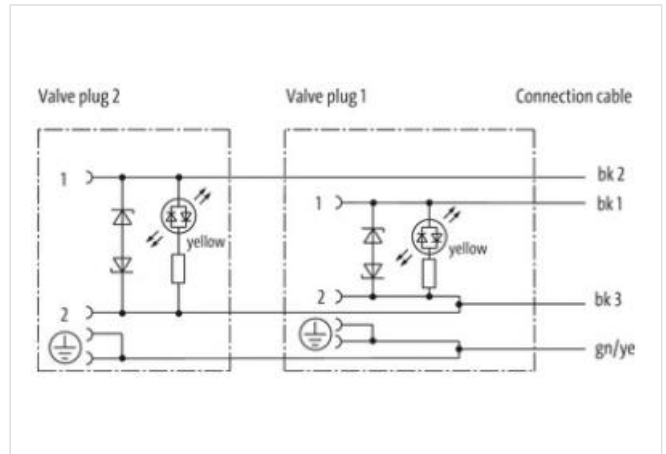

Produktet kan avvike fra bildet



Cable length 10 m

**Side 1**

Tightening torque 0,4 Nm

Thread	M3
Degree of protection (EN IEC 60529)	IP67
<b>Side 2</b>	
Tightening torque	0,4 Nm
Thread	M3
<b>Handelsinformasjon</b>	
ECLASS-6.0	27279218
ECLASS-6.1	27279218
ECLASS-7.0	27279218
ECLASS-8.0	27279218
ECLASS-9.0	27060312
ECLASS-10.1	27060312
ECLASS-11.1	27060312
ECLASS-12.0	27060312
ETIM-5.0	EC001855
GTIN	4048879442305
Pakkestørrelse	1
Tolltariffnummer	85444290
<b>Electrical data</b>	
Drop-out delay time max.	20 ms
<b>Electrical data   Supply</b>	
Operating voltage AC	110 V
Operating voltage AC min.	99 V
Operating voltage AC max.	121 V
Operating voltage DC	110 V
Operating voltage DC min.	99 V
Operating voltage DC max.	121 V
Cut-off peak voltage max.	250 V
Current operating per contact max.	1 A
<b>Diagnostics</b>	
Status indication LED	yellow
<b>Device protection   Electrical</b>	
Degree of protection (ISO 20653:2013)	IP66K
Additional condition protection degree	inserted, screwed
Pollution Degree	3
Rated surge voltage	2,5 kV
Material group (IEC 60664-1)	I
<b>Mechanical data   Material data</b>	
Coating locking	verzinkt
Color housing	black
Material housing	Plastic
Locking material	Steel
<b>Mechanical data   Mounting data</b>	
Mounting method	inserted, screwed
<b>Environmental characteristics   Climatic</b>	
Operating temperature min.	-25 °C
Operating temperature max.	85 °C
Additional condition temperature range	depending on cable quality
<b>Important installation notes</b>	
Note on strain relief	Protect the connectors by suitable measures from mechanical loads, e.g. by the usage of cable ties.

Note on bending radius

**Attention:** Observe the permissible bending radii when laying cables, as the IP protection class can be endangered by excessive bending forces.

Installation   Cable	
wire arrangement	black 1, black 2, black 3, green-yellow
Cable identification	227
Cable Type	2
Printing color of wire insulation	white (isolation black)
Jacket Color	gray
Type of Certificate	cURus
Amount stranding	1
Stranding	4 wires twisted
wire arrangement	black 1, black 2, black 3, green-yellow
Cable weight	74,8 g/m
Material jacket	PUR
Shore hardness jacket	85 ± 5 Shore A
Freedom from ingredients (jacket)	lead-free, cadmium-free, CFC-free, silicone-free
Outer-diameter (jacket)	7 mm
Tolerance outer diameter (sheath)	± 5 %
Material inner jacket	PVC
Color (inner jacket)	yellow
Material wire insulation	PVC
Amount wires	4
Outer diameter insulation	1,8 mm
Outer diameter tolerance core insulation	± 5 %
Shore hardness wire insulation	43 ± 5 Shore D
Ingredient freeness wire insulation	lead-free, cadmium-free, CFC-free, silicone-free
Printing color of wire insulation	white (isolation black)
Amount strands (wire)	42
Diameter of single wires	0,15 mm
Conductor crosssection (wire)	0,75 mm <sup>2</sup>
Material conductor wire	Stranded copper wire, bare
Conductor type (wire)	strand class 6
Electrical function wire	Signal
Nominal voltage AC max.	300 V
Current load capacity (standard)	to DIN VDE 0298-4
Current load capacity min. wire	9,6 A
Electrical function wire	Signal
Electrical resistance line constant wire	26 Ω/km @ 20 °C
Min. operating temperature (static)	-30 °C
Max. operating temperature (fixed)	80 °C
Operating temperature min. (dynamic)	-5 °C
Operating temperature max. (dynamic)	80 °C
chemical resistance	Good, application-related testing
Gasoline resistance	Good, application-related testing
Oil resistance	DIN EN 60811-404
Bending radius (fixed)	10 x Outer diameter
Bending radius (dynamic)	15 x Outer diameter
No. of bending cycles (C-track)	2 Mio. @ 25 °C
Traversing distance (C-track)	5 m @ 25 °C   horizontal
Travel speed (C-track)	3,3 m/s @ 25 °C