

M12 male 0° / M12 female 0° A-cod.

PUR AWG24+22 shielded vt UL/CSA+drag ch. 5.3m

DeviceNet, CANopen

Male straight – female straight

M12 – M12, 5-pole

A-coded

shielded

Plastic housings with good resistance against chemicals and oils.

The resistance to aggressive media should be individually tested for your application. Further details on request.

Further cable lengths on request.

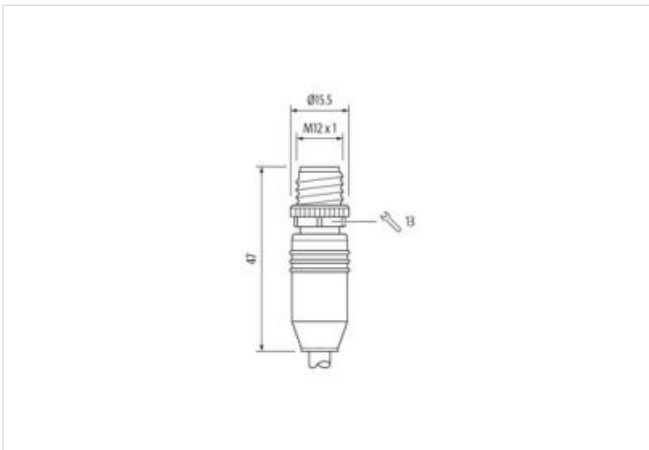
[Link to Product](#)**Illustration**

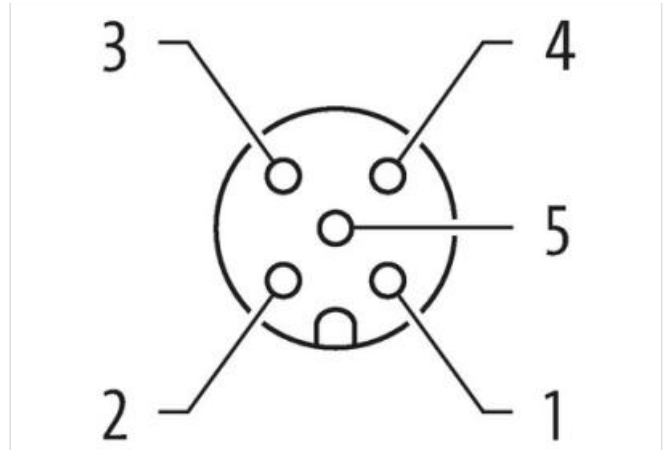

Product may differ from Image



Cable length	5,3 m
Side 1	
Tightening torque	0,6 Nm
Mounting method	inserted, screwed
Family construction form	M12
Thread	M12 x 1
Cable outlet	straight
Coding	A
Material	PUR
Width across flats	SW13
Degree of protection (EN IEC 60529)	IP65, IP66K, IP67
Side 2	
Tightening torque	0,6 Nm
Mounting method	inserted, screwed
Family construction form	M12
Thread	M12 x 1
Cable outlet	straight
Coding	A
Material	PUR
Width across flats	SW13
Commercial data	
ECLASS-6.0	27279218
ECLASS-6.1	27060307
ECLASS-7.0	27060307
ECLASS-8.0	27060307
ECLASS-9.0	27060307
ECLASS-10.1	27060307
ECLASS-11.1	27060307

ECLASS-12.0	27060307
ETIM-5.0	EC001855
customs tariff number	85444290
GTIN	4048879164924
Packaging unit	1

Electrical data | Supply

Operating voltage AC max.	60 V
Operating voltage DC max.	60 V
Operating voltage AC (UL-listed)	30 V
Operating voltage DC (UL-listed)	30 V
Current operating per contact max.	4 A

Installation | Connection

Mounting set	M12 x 1
--------------	---------

Device protection | Electrical

Additional condition protection degree	inserted, screwed
Pollution Degree	3
Rated surge voltage	1,5 kV
Material group (IEC 60664-1)	I

Mechanical data

Contour for corrugated hose	without
-----------------------------	---------

Mechanical data | Material data

Coating locking	Nickeled
Coating of fitting	nickel plated
Material gasket	FKM
Locking material	Zinc die-casting
Material screw connection	Zinc die-casting

Mechanical data | Mounting data

Mounting method	inserted, screwed, Shaking protection
-----------------	---------------------------------------

Environmental characteristics | Climatic

Operating temperature min.	-25 °C
Operating temperature max.	85 °C
Additional condition temperature range	depending on cable quality

Important installation notes

Note on strain relief	Protect the connectors by suitable measures from mechanical loads, e.g. by the usage of cable ties.
Note on bending radius	Attention: Observe the permissible bending radii when laying cables, as the IP protection class can be endangered by excessive bending forces.

Conformity

Product standard	DIN EN 61076-2-101 (M12)
------------------	--------------------------

Installation | Cable

wire arrangement	(white, blue), (black, red)
Cable identification	803
Jacket Color	violet
Type of Certificate	cURus
Amount stranding	1
Stranding	2 wires twisted
Amount stranding (type 2)	1
Stranding (type 2)	2 Stranded joints twisted
Cable shielding (type)	copper braid, tinned
Cable shielding (coverage)	65 %
Banding	Foil
Drain wire (cross-section)	22 AWG

wire arrangement	(white, blue), (black, red)
Cable weight	63,12 g/m
Material jacket	PUR
Shore hardness jacket	90 ± 5 Shore A
Freedom from ingredients (jacket)	lead-free, cadmium-free, CFC-free, halogen-free, silicone-free
Outer-diameter (jacket)	6,9 mm
Tolerance outer diameter (sheath)	± 5 %
Material wire insulation	PE
Amount wires	2
Outer diameter insulation	2,1 mm
Outer diameter tolerance core insulation	± 5 %
Shore hardness wire insulation	64 ± 5 Shore D
Ingredient freeness wire insulation	lead-free, CFC-free, halogen-free
Amount strands (wire)	19
Diameter of single wires	24 AWG
Conductor crosssection (wire)	24 AWG
Drain wire (cross-section)	22 AWG
Material conductor wire	copper stranded wire, tinned
Electrical function wire	Data
Material wire insulation (Data)	PE
Outer diameter wire insulation (Data)	1,5 mm
Tolerance outer diameter wire insulation (data)	± 53 %
Ingredient freeness wire insulation (Data)	lead-free, CFC-free, halogen-free
Amount wires (Data)	2
Amount strands wire (Data)	19
Diameter of single wires (Data)	22 AWG
Conductor crosssection wire (Data)	22 AWG
Material conductor wire (Data)	copper stranded wire, tinned
Electrical function wire (data)	Power
Nominal voltage AC max.	300 V
Current load capacity (standard)	to DIN VDE 0298-4
Current load capacity min. wire	4,5 A
Current load capacity min. Wire (Data)	6 A
Electrical function wire	Data
Electrical function wire (data)	Power
Characteristic impedance	120 Ω ± 10 % @ 1 MHz
Electrical resistance line constant wire	78 Ω/km
Electrical resistance coating wire (Data)	54 Ω/km
AC withstand voltage (wire - wire)	2 kV @ 60 s
Electric capacitance	40000 pF/km
AC withstand voltage (wire - shield)	2 kV @ 60 s
Min. operating temperature (static)	-40 °C
Max. operating temperature (fixed)	80 °C
Operating temperature min. (dynamic)	-30 °C
Operating temperature max. (dynamic)	70 °C
Flame resistance	UL 1581 § 1100 FT2 IEC 60332-2-2 UL 1581 § 1090
chemical resistance	Good, application-related testing
Gasoline resistance	Good, application-related testing
Oil resistance	DIN EN 60811-404 Good, application-related testing
Bending radius (installation)	x Outer diameter
Bending radius (fixed)	6 x Outer diameter
Bending radius (dynamic)	10 x Outer diameter
No. of bending cycles (C-track)	1 Mio.
Traversing distance (C-track)	5 m

The information in this Product-PDF has been compiled with the utmost care.

Liability for the correctness completeness and topicality of the information is restricted to gross negligence. Version: 2024-06-26

Murrelektronik A.S. | Christian August Thorings vei 7 | 4033 Stavanger | Fon +47 32 1790-80 | Fax +47 32 1790-90 | shop@murrelektronik.no | shop.murrelektronik.no

Travel speed (C-track)	3 m/s
No. of torsion cycles	2 Mio.
Torsion stress	± 30 °/m
Torsion speed	35 cycles/min